

ROOM THERMOSTAT WITH BACKLIT DISPLAY

PT22



- for all types boilers
- weekly program (preset)
- 6 temp. changes per every day
- anti-freeze mode
- easy installation
- modern design

- **BIG WELL-ARRANGED DISPLAY**
with navigation in selected language

EOB
s.r.o.
ELEKTROBOCK CZ
MADE IN CZECH REPUBLIC

DESCRIPTION

PT22 is digital room thermostat with backlit display for automatic regulation of heating. Its advantages involve a quick change in the desired temperature by simply turning the wheel, and possibility of setting up to weekly program with 6 temperature changes per day.

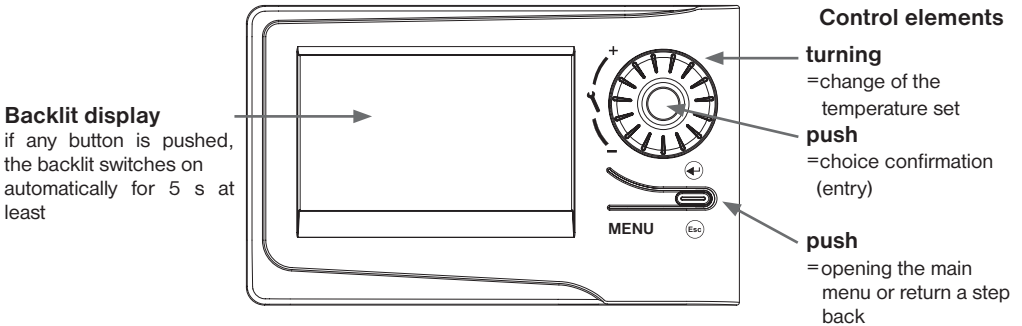

INSTALLATION AND LOCATION

Install the thermostat at a suitable place where its operation cannot be affected by direct flow of hot air from the heater, sunshine or other disturbing effects. Do not install it on an external wall either. The installation height should be approx. 1.5 m above the floor. Place the thermostat in the "reference room", such as the living room (the heating source will switch according to the temperature in this room).

The installation must only be done by a properly qualified person!
Before installation, disconnect the power supply!

- 1) Switch off the main circuit breaker.
- 2) Remove the control part from the lower cover of the device (Fig.1).
- 3) Chip away the central plastic piece from the lower cover to lead in conductors.
- 4) Run the conductor through the hole and connect it to the terminal acc. to the diagram.
- 5) Fasten the lower cover to the wiring box with screws (Fig. 2).
- 6) Batteries are located at the back of the control part. Remove their protective paper (on first use), or insert new batteries (follow the instructions on page 3).
- 7) Mount the control part on the lower cover.
- 8) Switch on the main circuit breaker and test correct connection of the thermostat, see page 5 (TEST).
- 9) Upon first start (or reset), the thermostat displays "SET CLOCK", set the current time and date according to page 4.

Wiring diagram:

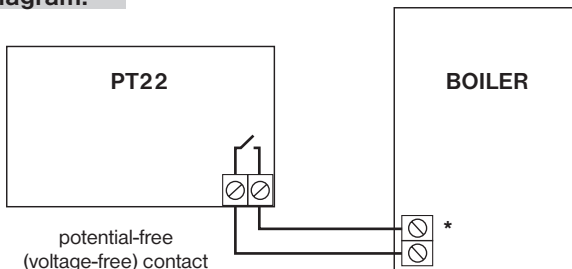

* The thermostat terminals are marked differently with every type of boiler. Therefore, follow the wiring prescribed by the boiler manufacturer!

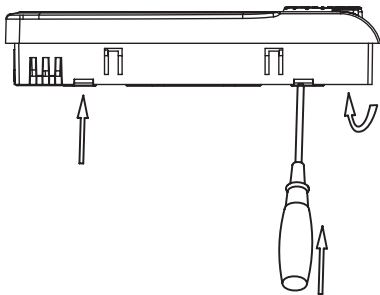
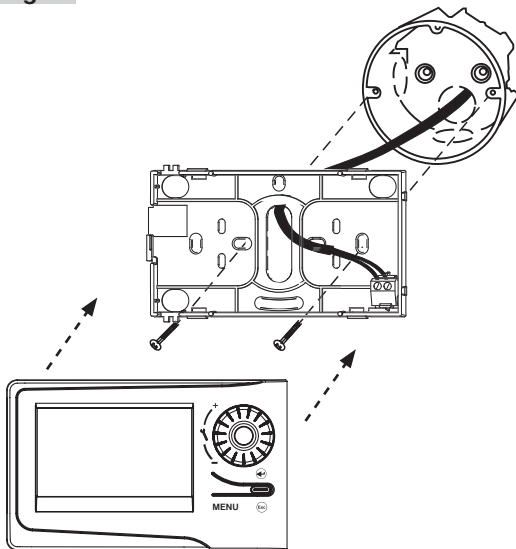
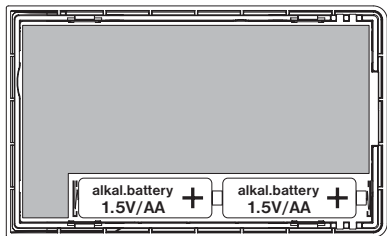
Fig.1**Fig.2****Fig.3**

HINTS FOR THE USER

QUICK CHANGE OF THE DESIRED TEMPERATURE

Press the “ \oplus ” button twice, the desired temperature starts blinking on the display. Change the temperature by turning the “ \setminus ” button, and press the “ \oplus ” button.

In the AUTO mode, the change lasts until the next program change.

In the MANU mode, the change is permanent.

BATTERY REPLACEMENT

As soon as “ \blacksquare ” appears on the display, you must replace the batteries.

- 1) Remove the control part from the lower cover of the device (Fig. 1).
- 2) Replace the batteries. Heed the correct polarity marked in the battery compartment (Fig. 3). After removing the batteries, all setting of the thermostat are saved in the E-EPROM memory 20 sec, only!

Always use the **type AA, 2 x 1.5 V**, alkaline batteries!

Recommendation: Check the batteries before every heating season!

Dispose of old batteries in conformity with regulations on hazardous waste treatment!

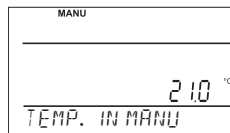
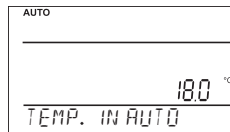

OPERATIONAL MODES

The first push of any button activates the display backlight. Pushing the “**MENU**” button shortly again, you open the main menu where you can choose the operational mode.

AUTO (weekly program is factory-set, see page 6)

The thermostat works according to the weekly program preset (this program can be changed; see PROG for detailed description).

Press the “**MENU**” button twice; select the AUTO mode by turning “**↘**”, and confirm with the “**↻**” button.



MANU (the 21 °C temperature is factory - set)

The thermostat works according to the temperature preset until the next manual change.

Press the “**MENU**” button twice; select the MANU mode by turning “**↘**”, and confirm with the “**↻**” button.



OFF (anti-freeze temperature of 3 °C is kept – cannot be changed)

The thermostat is off until the next manual change of the mode.

Press the “**MENU**” button twice; select the OFF mode by turning “**↘**”, and confirm with the “**↻**” button.

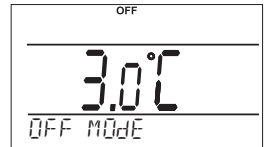

DOVOLENÁ

The thermostat keeps the temperature preset until the given date. When the preset time lapses, it automatically returns to the last-selected AUTO/MANU mode before the holiday.

Press the “**MENU**” button twice; select the  mode by turning “**↘**”, and confirm with the “**↻**” button.

Stepwise, set the temperature which the thermostat should keep during the holiday, and date of your return from the holiday. Change the values by turning “**↘**”, and always confirm them pushing the “**↻**” button. When the setting is finished, press the “**Esc**” button to return to the basic screen.

Note: You can cancel the holiday mode any time by choosing another AUTO or MANU mode.

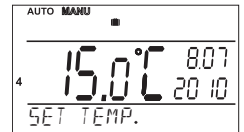
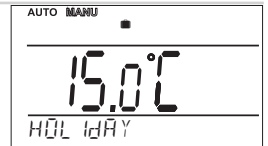

CLOCK SETTING

Setting the current time and date.

Press the “**MENU**” button twice; select the CLOCK mode by turning “**↘**”, and confirm with the “**↻**” button.

Change the values turning the “**↘**” button. Always push the “**↻**” button to confirm (the value set is always blinking; the “**Esc**” button returns you to the menu).

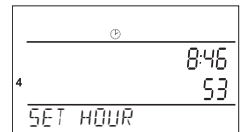
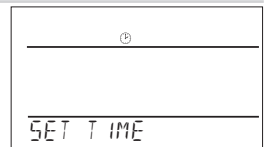

PROG (PROGRAMMING)

Setting the weekly program with up to 6 changes per day.
Press twice the "MENU" button, choose the **PROG** mode by turning the "↖" button, and press the "⊕" button to confirm. The number of days to be programmed is blinking on the display; choose one of the options by turning the "↖" button (you can program day-by-day or 1-5 = Mon-Fri, 6-7 = Sat-Sun or 1-7 = Mon-Sun) and press the "⊕" button to confirm. The **1st change time** starts flashing; set the time by turning the "↖" button and press the "⊕" button to confirm. Set the temperature for this time by turning the "↖" button and press again the "⊕" button to confirm. The **2nd change time** appears on the display. Proceed in the same way as with the first change setting. In this way, you can set up to **6 temperature changes per day**. To return to the menu, press the "Esc" button.

After changing the preset program, check whether all the changes made conform to your requirements!

It is not necessary to apply all six changes in one day!

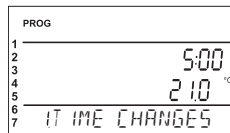
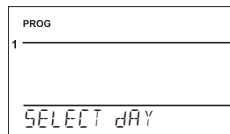
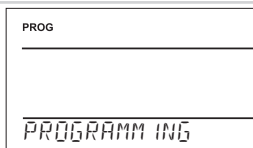

CONST (CONSTANTS)

Setting the control parameters.

Press twice the "MENU" button, choose the **CONST** mode by turning the "↖" button, and press the "⊕" button to confirm.

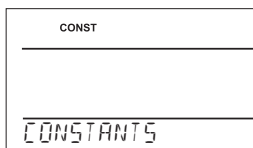

1 CESKY (Czech language set by default)

Language selection (CZ/PL/EN/DE).

Choose the language by turning the "↖" button and press the "⊕" button to confirm.

2 HYSTEREZE (0.5°C set by default)

The hysteresis can be set **from 0,1 to 6°C**. **Example:** If the hysteresis is 1 °C and the required temperature 20 °C, the thermostat switches off at 20 °C and on again at 19 °C.

Set the value by turning the "↖" button and press the "⊕" button to confirm.

3 TEST

We recommend you to use the test when you first use the thermostat!

After you turn the "↖" button, the test starts and the output relay is switched on/off several times (the display shows the ON/OFF message). Pressing the "⊕" button, you can view the next constant; to return to the main menu, press the "Esc" button.

4 VERSION (restoring the default settings)

Firmware version, informative parameter only.

If you press the "Esc" button long (for about 3 s), the RESET message appears shortly on the LCD and the thermostat returns to the default settings!

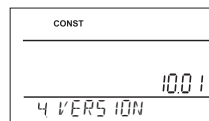
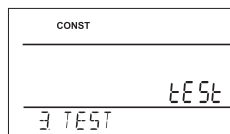
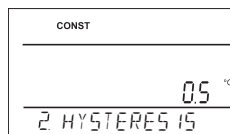
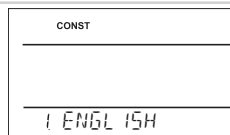

ROOM THERMOSTAT

PT22

PT22 is a battery-powered room temperature. The big, well-arranged graphic display offers intuitive navigation in the selected language (CZ / PL / EN / DE). The backlit display enables thermostat control even at night. With preset program can PT22, after installation, and set the current time, immediately used without further adjustment.

Properties:

- ▶ weekly program with 6 temp. changes per day (can be changed)
- ▶ big backlit display
- ▶ possibility of setting HYSTERESIS
- ▶ operational modes
AUTO/ MANU/ OFF/ HOLIDAY
- ▶ short-term change in the required temp.
- ▶ auto SUMMER/ WINTER time change

Preset weekly program:

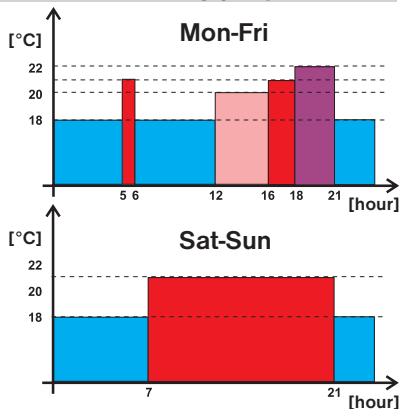

HYSTERESIS explanation:

The hysteresis can be set from 0,1 to 6°C.

Example: If the hysteresis is 1 °C and the required temperature 20 °C, the thermostat switches off at 20 °C and on again at 19 °C.

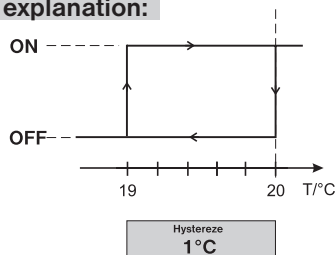

Dimensions:

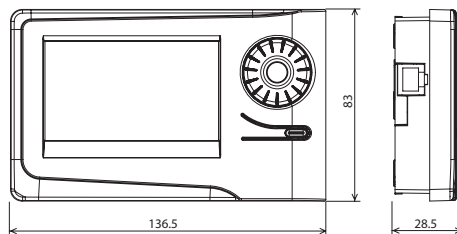

CERTIFICATE OF GUARANTEE

(guarantee period for the product amounts to 2 years)

product No.:	date of sale:
	stamp of shop:
examined by:	

Technical parameters

Power supply	2x 1.5V alkal. batteries typ AA
Number of temp. changes	6 temperature changes per day
Hysteresis	0.1 to 6°C
Minimum program. time	10 minutes
Adjustable temp. range	+5°C to 39°C
Temperature setting	po 0,5°C
Minimální indikační skok	0.1°C
Measurement accuracy	± 0,5°C
Battery life	heating season
Protection	IP20
Output	max.5A (potential-free contacts)
Working temp.	0°C to +40°C



In case of guarantee or post-guarantee service, send the thermostat to the manufacturer's address.



ELEKTROBOCK CZ s.r.o.
Blanenská 1763
Kuřim 664 34
Tel./fax: +420 541 230 216

www.elbock.cz